

PKL 01 LED PARKING LOT LIGHT



* Product features:

- Premium-quality LEDs provided by Samsung/ Seoul Semiconductor/ Nichia/ Lumiled with excellent performance
- High luminous efficacy of up to 150 lm/W
- Aluminum housing with perfect heat dissipation
- PC cover with high lighting transmittance and desired lighting distribution
- Curved light-emitting surface to improve overall light uniformity
- CE, KC certified
- Long life span: 25,000 hours, saving the maintenance cost
- Options:
 - + Integrated with a PIR sensor/ Light sensor/ Radar Sensor
 - + Smart control: Users can freely adjust the brightness and response time of the lights individually or by group thanks to the built-in sensor and Rang Dong's smart app.

* Applications:

- Parking lots, subways, commercial buildings
- Entryways, hallways, outdoor lighting
- Warehouses, factories, gymnasiums, etc.





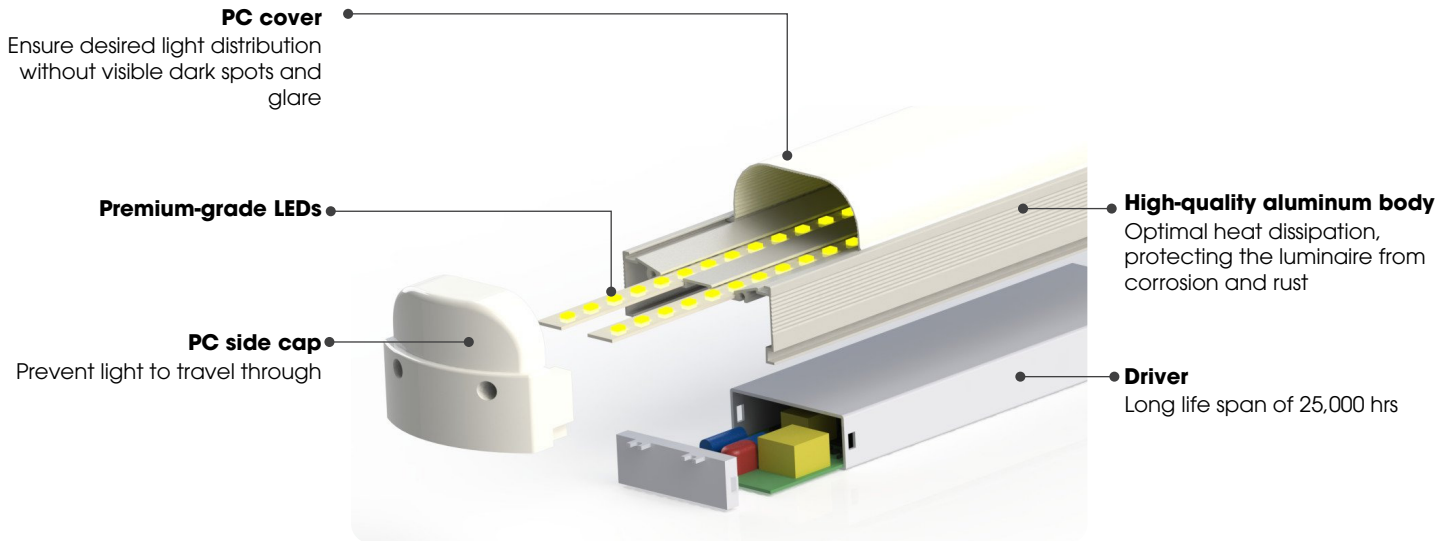

PRODUCT DETAILS

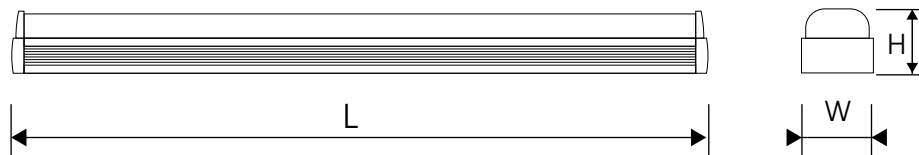

PRODUCT SPECIFICATIONS



Model	Dimension LxWxH (mm)	Power (W)	Voltage (V)	Power factor	Luminous flux (lm)	Luminous efficacy (lm/W)	CCT (K)	Life span (hrs)	Market
PKL01 600/20W	600x58x46	20	120/ 220÷240/ 100÷277	0.9	1800/2200	90/110	3000/4000/5000/5700/6500	25,000	
PKL01 1200/40W	1200x58x46	40	120/ 220÷240/ 100÷277	0.9	3600/4400	90/110	3000/4000/5000/5700/6500	25,000	
PKL01 1200/50W	1200x58x46	50	120/ 220÷240/ 100÷277	0.9	4500/5500	90/110	3000/4000/5000/5700/6500	25,000	
PKL01 1200/60W	1200x58x46	60	120/ 220÷240/ 100÷277	0.9	5400/6600	90/110	3000/4000/5000/5700/6500	25,000	

Capacity: 3.2 million pieces per year

Customizable: Power (20/40/50/60W), Voltage (120/220÷240/100÷277V), Luminous efficacy (up to 150lm/W), CCT (3000/4000/5000/5700/6500K), Motion sensor/ smart, Life span, etc.

LUMINOUS INTENSITY DISTRIBUTION

PKL01 600/20W

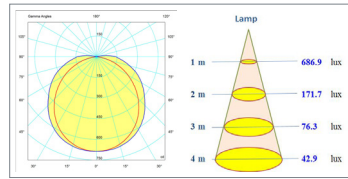

PKL01 1200/40W

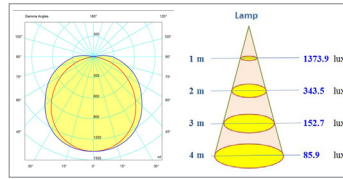

PKL01 1200/50W

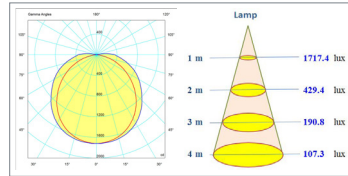

PKL01 1200/60W

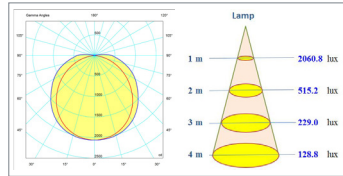

PACKING AND TRANSPORTATION

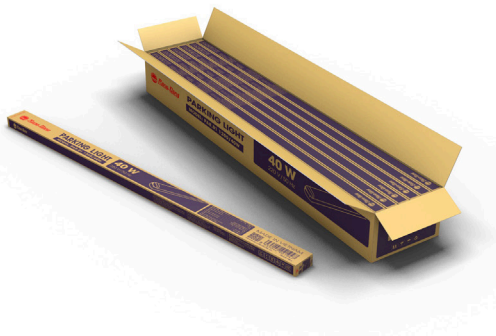

Type of lamps	Quantity in master box (pcs)	Estimated quantity/ 20'DC	Estimated quantity/ 40'HC
PKL01 600/20W	6	10 620	24 390
PKL01 1200 40W/50W/60W	6	5 484	12 588

Customizable according to customer's request



Exported market: South Korea, EU, etc



RANG DONG LIGHT SOURCE AND VACUUM FLASK JOINT STOCK COMPANY

Add: 87- 89 Ha Dinh Street, Thanh Xuan, Hanoi, Vietnam

Tel: (84-24) 3 858 4310 / 3 858 4165

Fax: (84-24) 3 858 5038

Email: export@rangdong.com.vn



Specifications are subject to change without prior notice